

DNA Expressions

A Formal Notation for DNA

voor leken

Rudy van Vliet

10 december 2015

Proosten

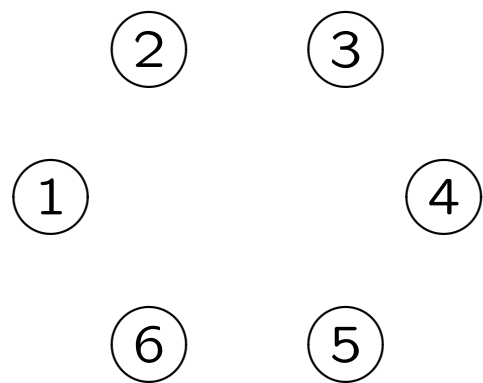

Proosten

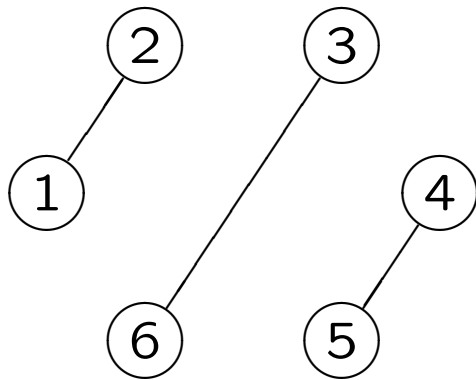

OK

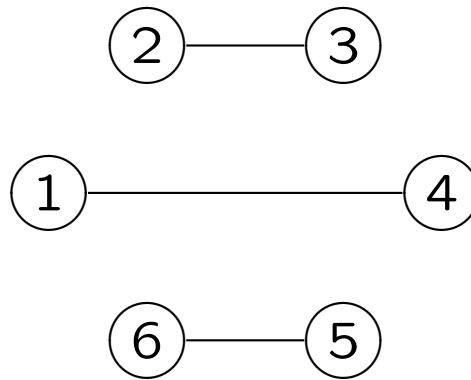

OK

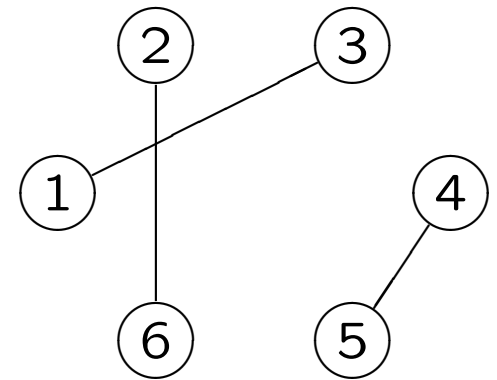

niet OK

DNA



DNA



DNA

- Bouwstenen: nucleotiden (basen) A, C, G, T
- Strengen: ACATG
- Complementen: A–T, C–G
- ACATG
- TGTAC

DNA

- Bouwstenen: nucleotiden (basen) A, C, G, T
- Strengen: ACATG
- Complementen: A–T, C–G

ACATG

- TGTAC

ACATG

- Sterk – zwak TGTAC

- Kort – lang

DNA

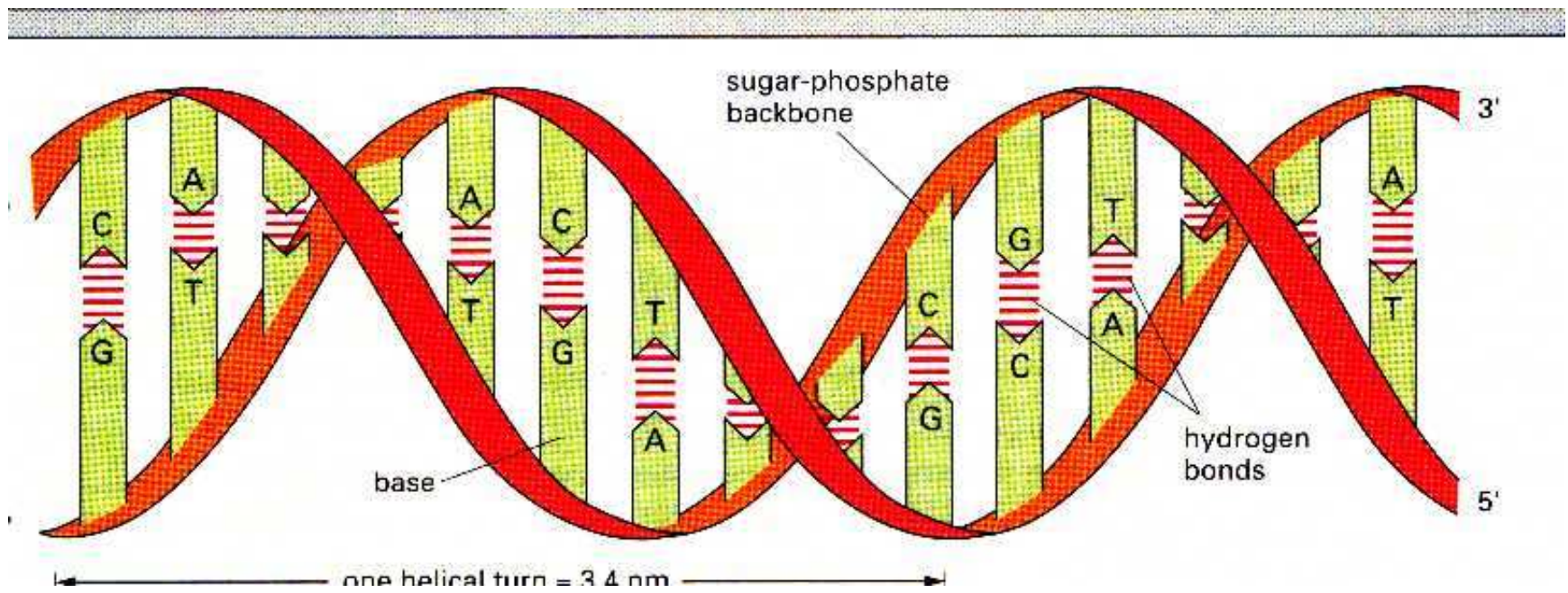

Adlemans experiment

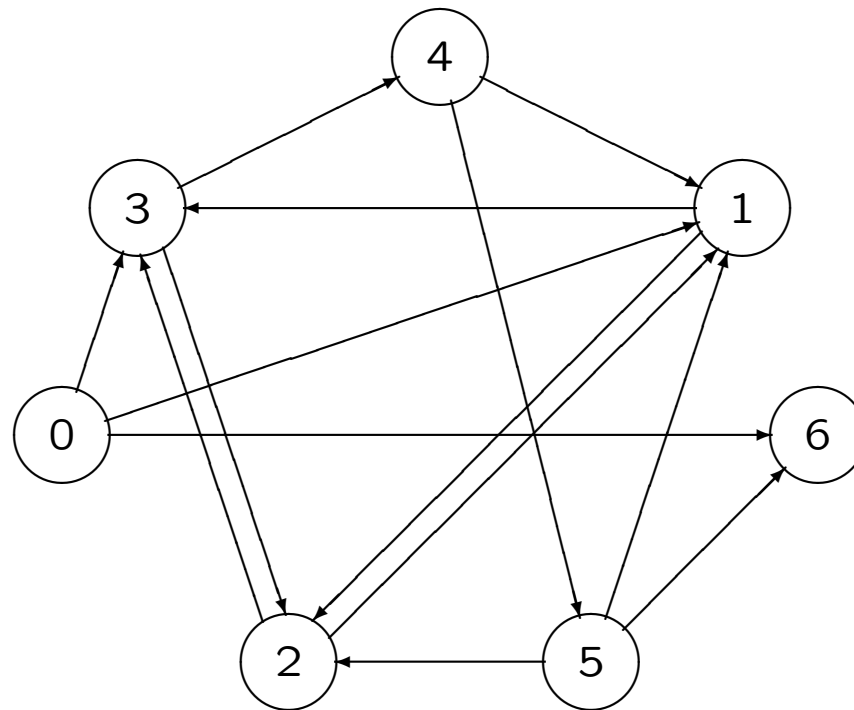

Formele notatie

- voor ACATG

- voor $\begin{array}{c} \text{ACATG} \\ \text{TGTAC} \end{array}$

- voor $\begin{array}{c} \nabla \text{ACATG} \\ \text{TGT} \triangle \text{AC} \end{array}$ (nicks)

- voor $\begin{array}{c} \text{ACAT} \\ \text{T TACG} \end{array}$ (gaps)

- voor ...

DNA-Expressies

- \mathcal{N} -letters: A, C, G en T
- \mathcal{N} -woord: ACATG
- operatoren: \uparrow , \downarrow , \updownarrow
- $(3 + (5 * 7))$

DNA-Expressies

- \mathcal{N} -letters: A, C, G en T
- \mathcal{N} -woord: ACATG
- operatoren: \uparrow , \downarrow , \updownarrow
- $(3 + (5 * 7))$
- $\langle \uparrow \text{ACATG} \rangle$
- $\langle \downarrow \text{TGTAC} \rangle$
- $\langle \updownarrow \text{ACATG} \rangle$
- DNA-expressies en/of \mathcal{N} -woorden als argumenten

Betekenis DNA-expressies

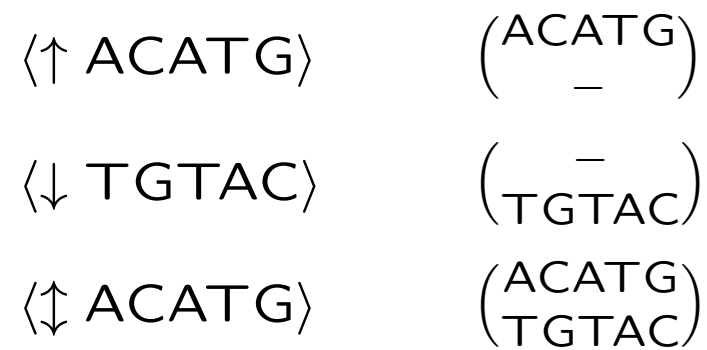

Betekenis DNA-expressies

$\langle \uparrow \text{ACATG} \rangle$	$\begin{pmatrix} \text{ACATG} \\ - \end{pmatrix}$
$\langle \downarrow \text{TGTAC} \rangle$	$\begin{pmatrix} - \\ \text{TGTAC} \end{pmatrix}$
$\langle \updownarrow \text{ACATG} \rangle$	$\begin{pmatrix} \text{ACATG} \\ \text{TGTAC} \end{pmatrix}$
$\langle \updownarrow \text{AT} \rangle$	$\begin{pmatrix} \text{AT} \\ \text{TA} \end{pmatrix}$
$\langle \downarrow \langle \updownarrow \text{AT} \rangle \text{CG} \rangle$	$\begin{pmatrix} \text{AT} \\ \text{TA} \end{pmatrix} \begin{pmatrix} - \\ \text{CG} \end{pmatrix}$
$\langle \uparrow \langle \updownarrow \text{A} \rangle \text{C} \langle \downarrow \langle \updownarrow \text{AT} \rangle \text{CG} \rangle \rangle$	$\begin{pmatrix} \text{A} \\ \text{T} \end{pmatrix} \begin{pmatrix} \text{C} \\ - \end{pmatrix} \begin{pmatrix} \text{AT} \\ \text{TA} \end{pmatrix} \begin{pmatrix} - \\ \text{CG} \end{pmatrix}$

Betekenis DNA-expressies

$\langle \uparrow \text{ACATG} \rangle$	$\begin{pmatrix} \text{ACATG} \\ - \end{pmatrix}$
$\langle \downarrow \text{TGTAC} \rangle$	$\begin{pmatrix} - \\ \text{TGTAC} \end{pmatrix}$
$\langle \updownarrow \text{ACATG} \rangle$	$\begin{pmatrix} \text{ACATG} \\ \text{TGTAC} \end{pmatrix}$
$\langle \updownarrow \text{AT} \rangle$	$\begin{pmatrix} \text{AT} \\ \text{TA} \end{pmatrix}$
$\langle \downarrow \langle \updownarrow \text{AT} \rangle \text{CG} \rangle$	$\begin{pmatrix} \text{AT} \\ \text{TA} \end{pmatrix} \begin{pmatrix} - \\ \text{CG} \end{pmatrix}$
$\langle \uparrow \langle \updownarrow \text{A} \rangle \text{C} \langle \downarrow \langle \updownarrow \text{AT} \rangle \text{CG} \rangle \rangle$	$\begin{pmatrix} \text{A} \\ \text{T} \end{pmatrix} \begin{pmatrix} \text{C} \\ - \end{pmatrix} \begin{pmatrix} \text{AT} \\ \text{TA} \end{pmatrix} \begin{pmatrix} - \\ \text{CG} \end{pmatrix}$
$\langle \uparrow \text{C} \langle \updownarrow \text{AT} \rangle \rangle$	$\begin{pmatrix} \text{C} \\ - \end{pmatrix} \begin{pmatrix} \text{AT} \\ \text{TA} \end{pmatrix}$
$\langle \downarrow \langle \uparrow \text{C} \langle \updownarrow \text{AT} \rangle \rangle \langle \updownarrow \text{G} \rangle \rangle$	$\begin{pmatrix} \text{C} \\ - \end{pmatrix} \begin{pmatrix} \text{AT} \\ \text{TA} \end{pmatrix} \nabla \begin{pmatrix} \text{G} \\ \text{C} \end{pmatrix}$

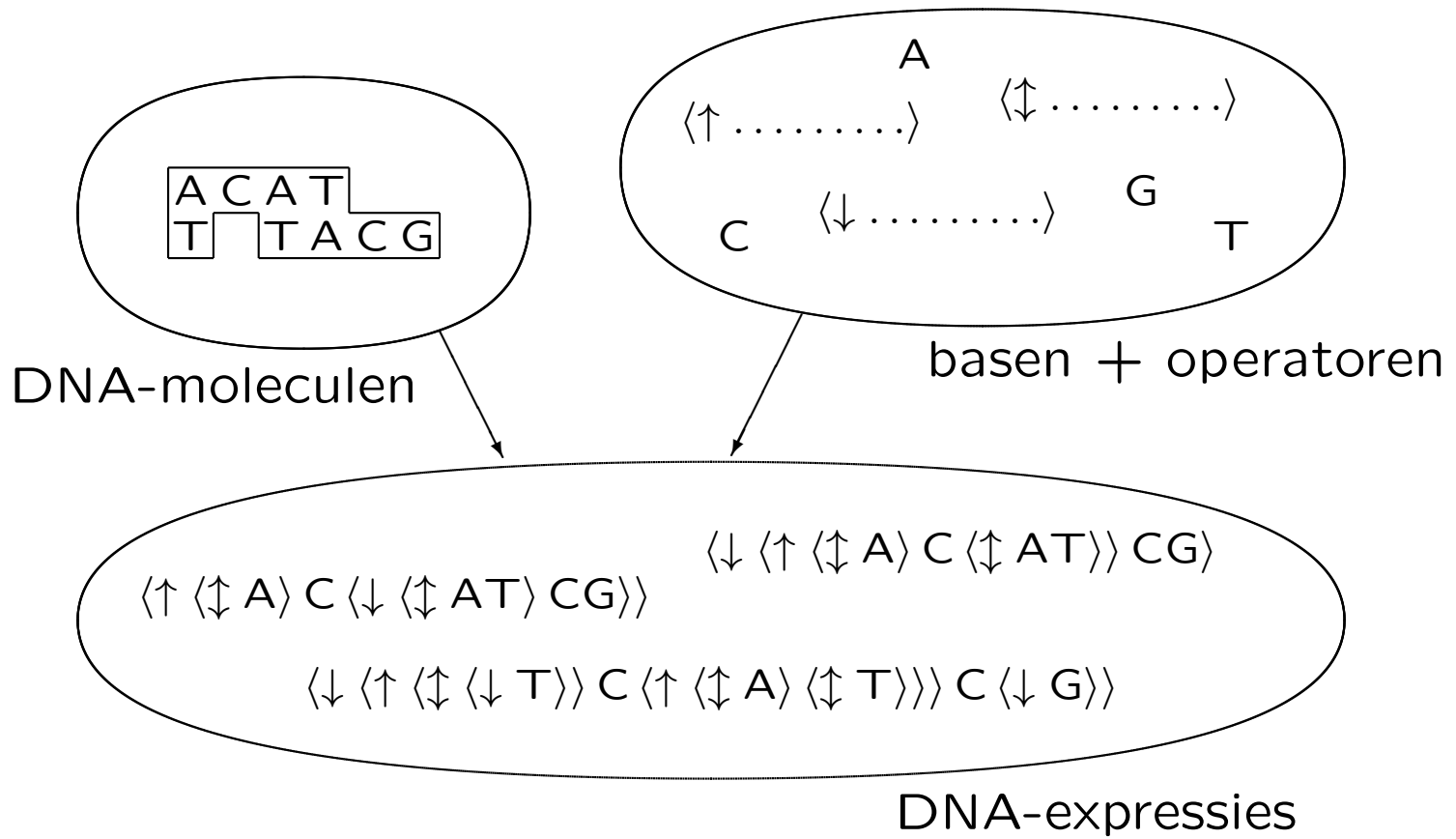

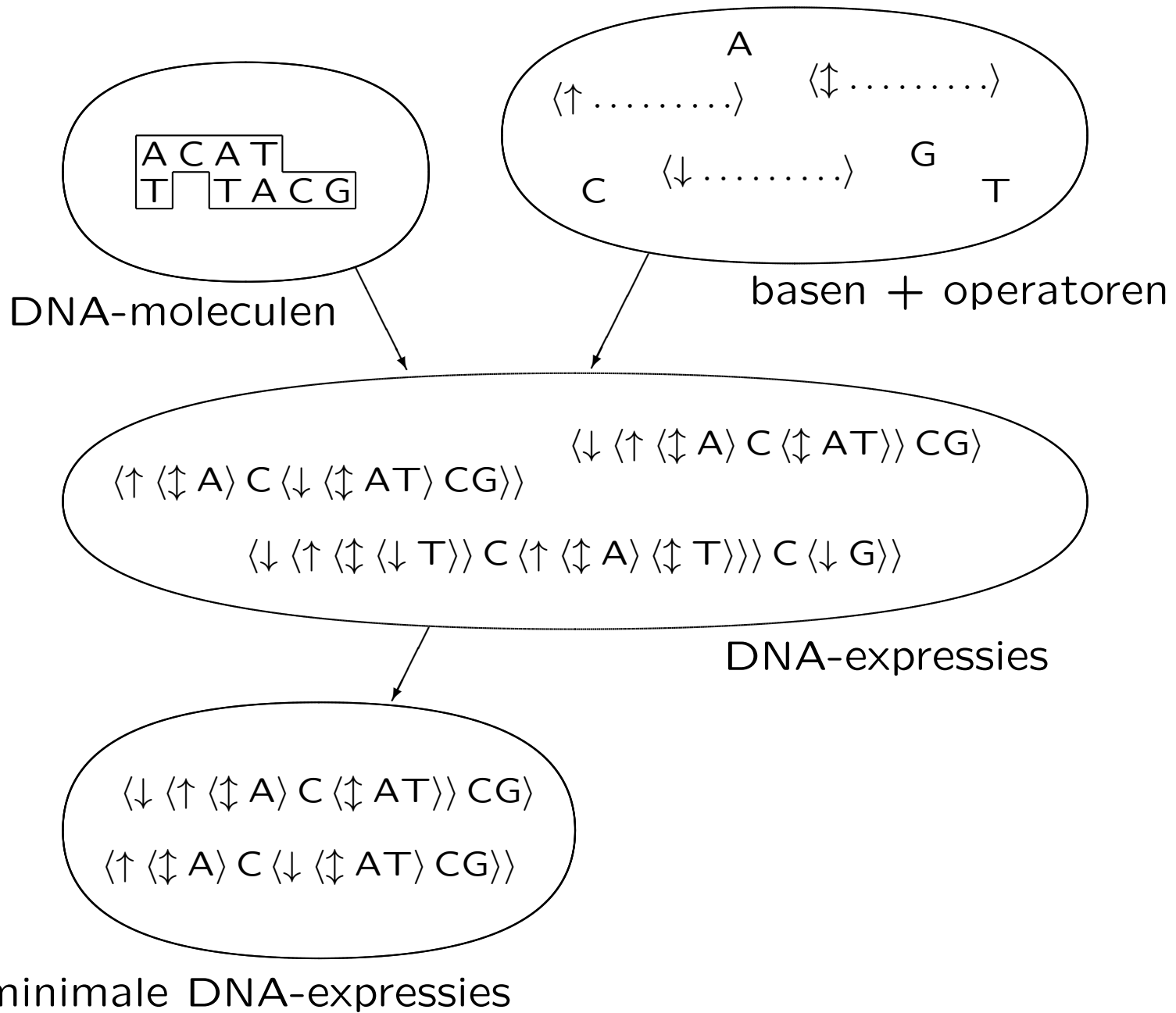

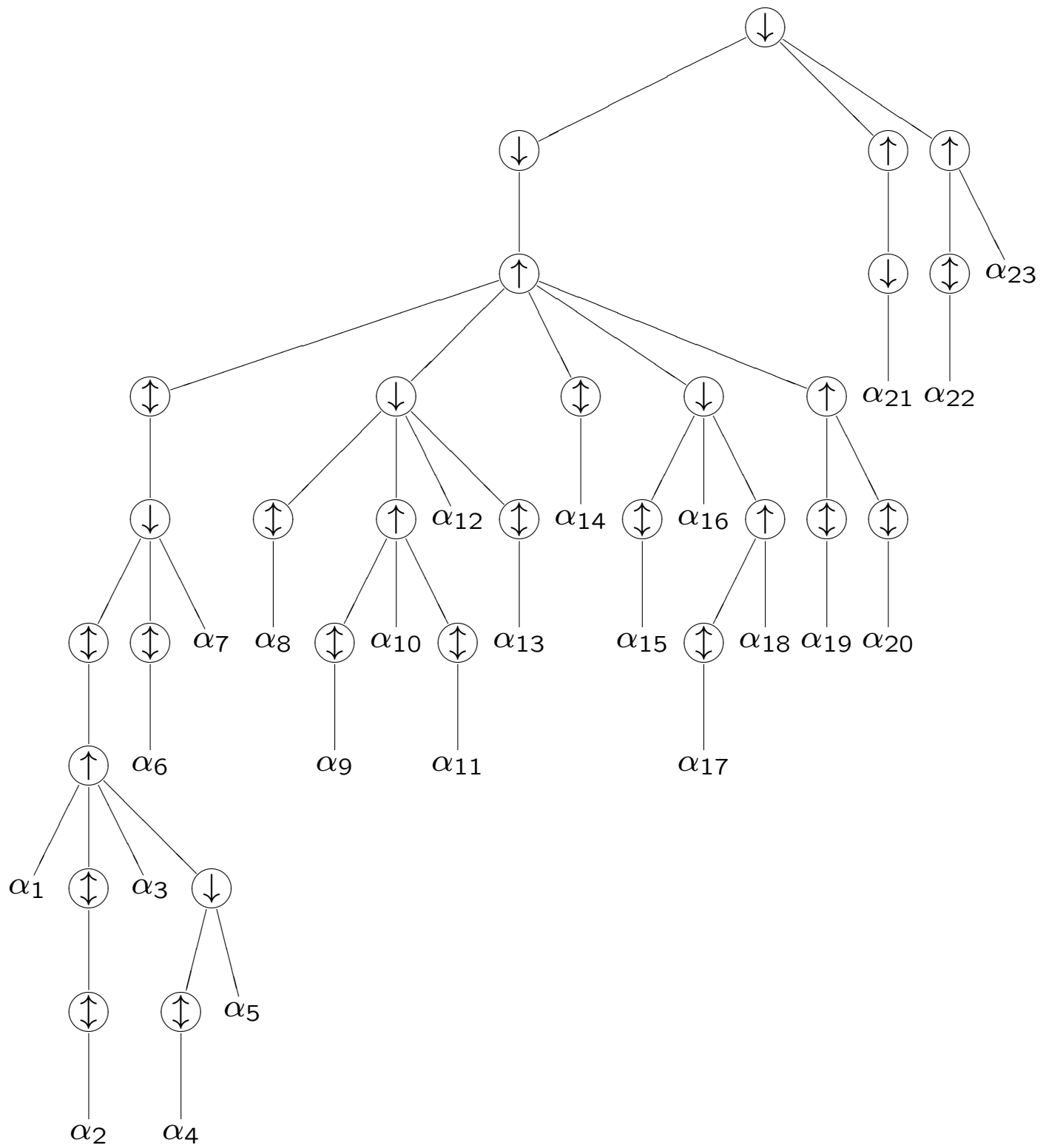

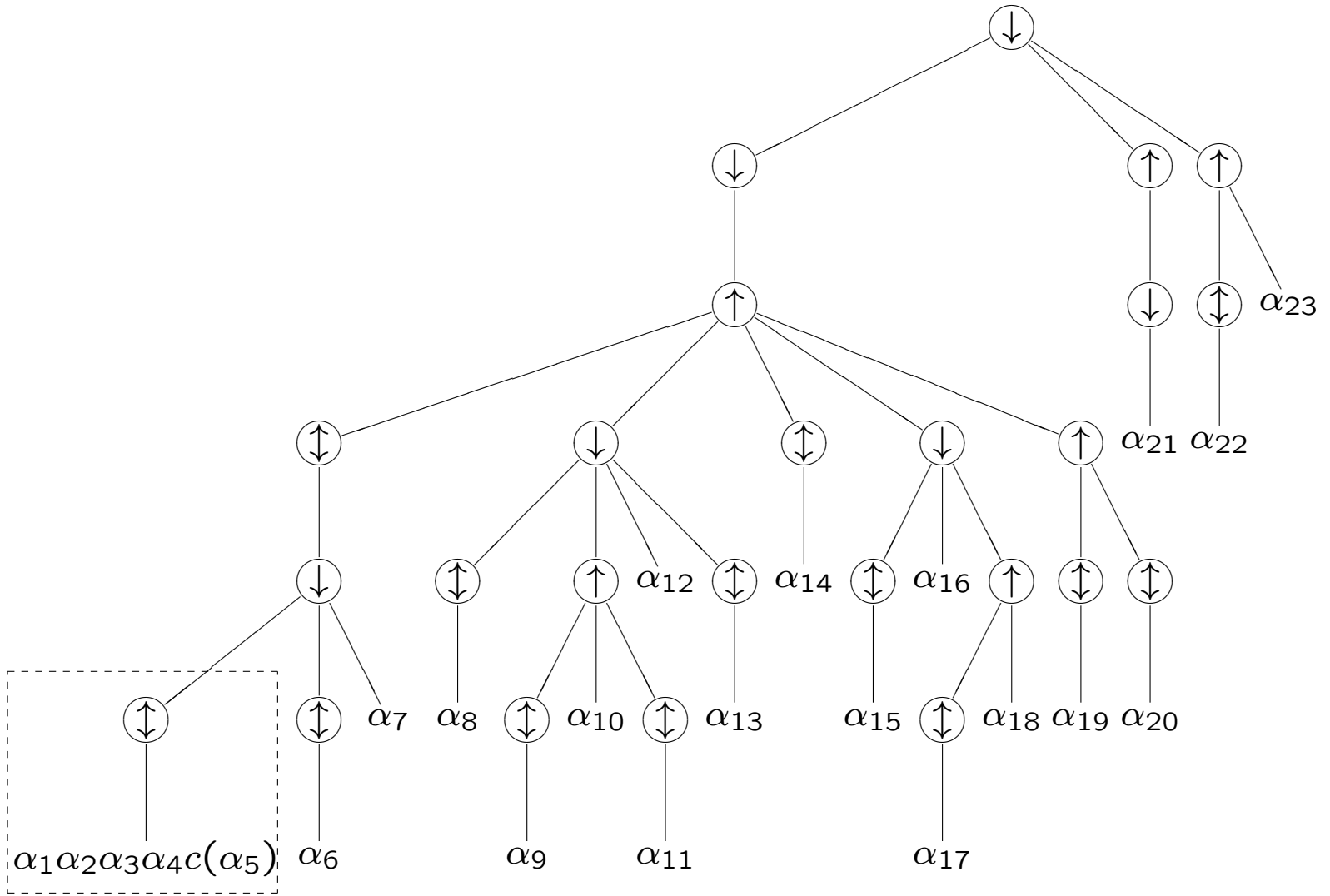

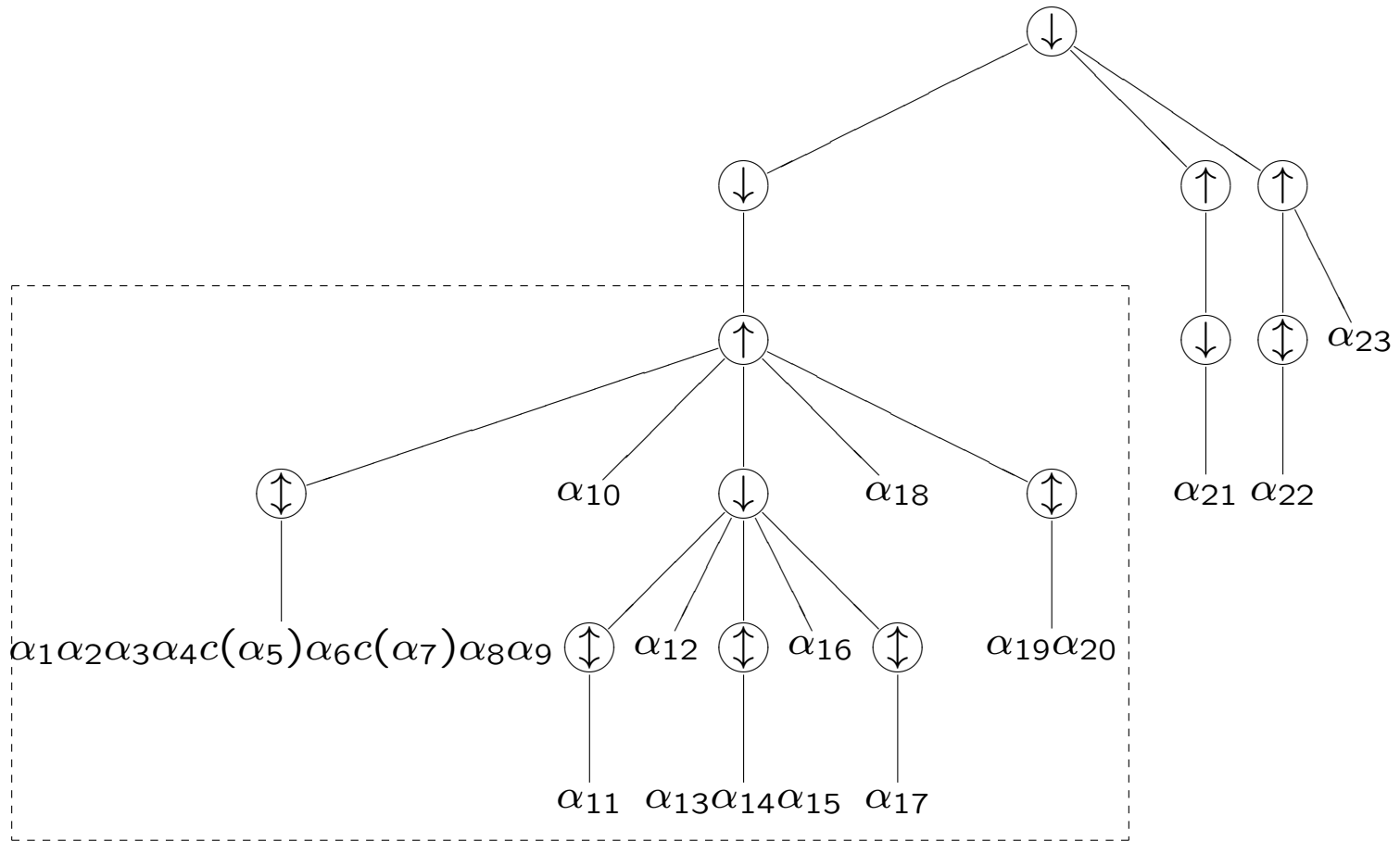

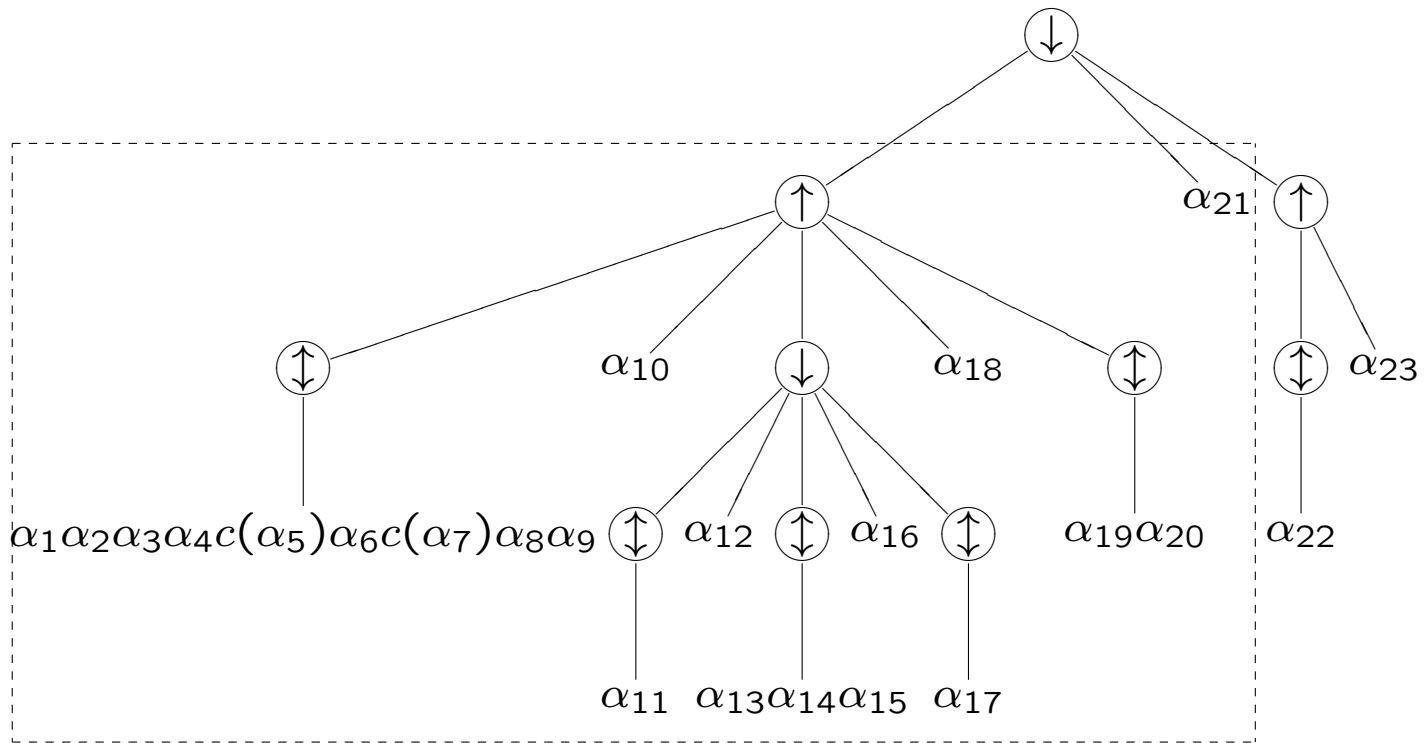

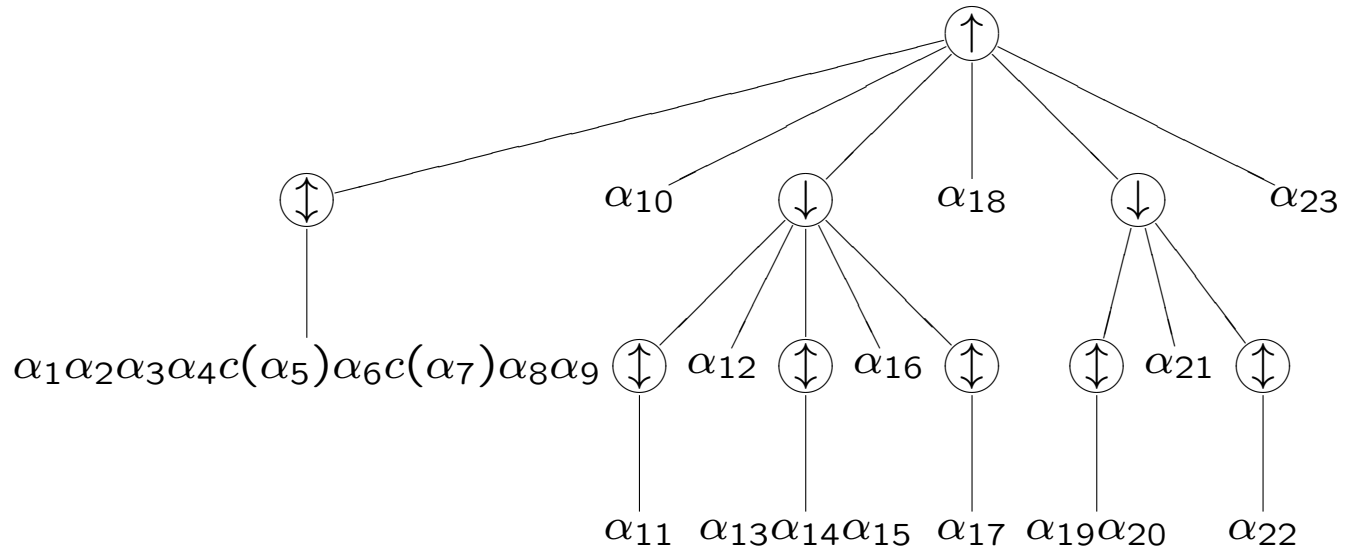

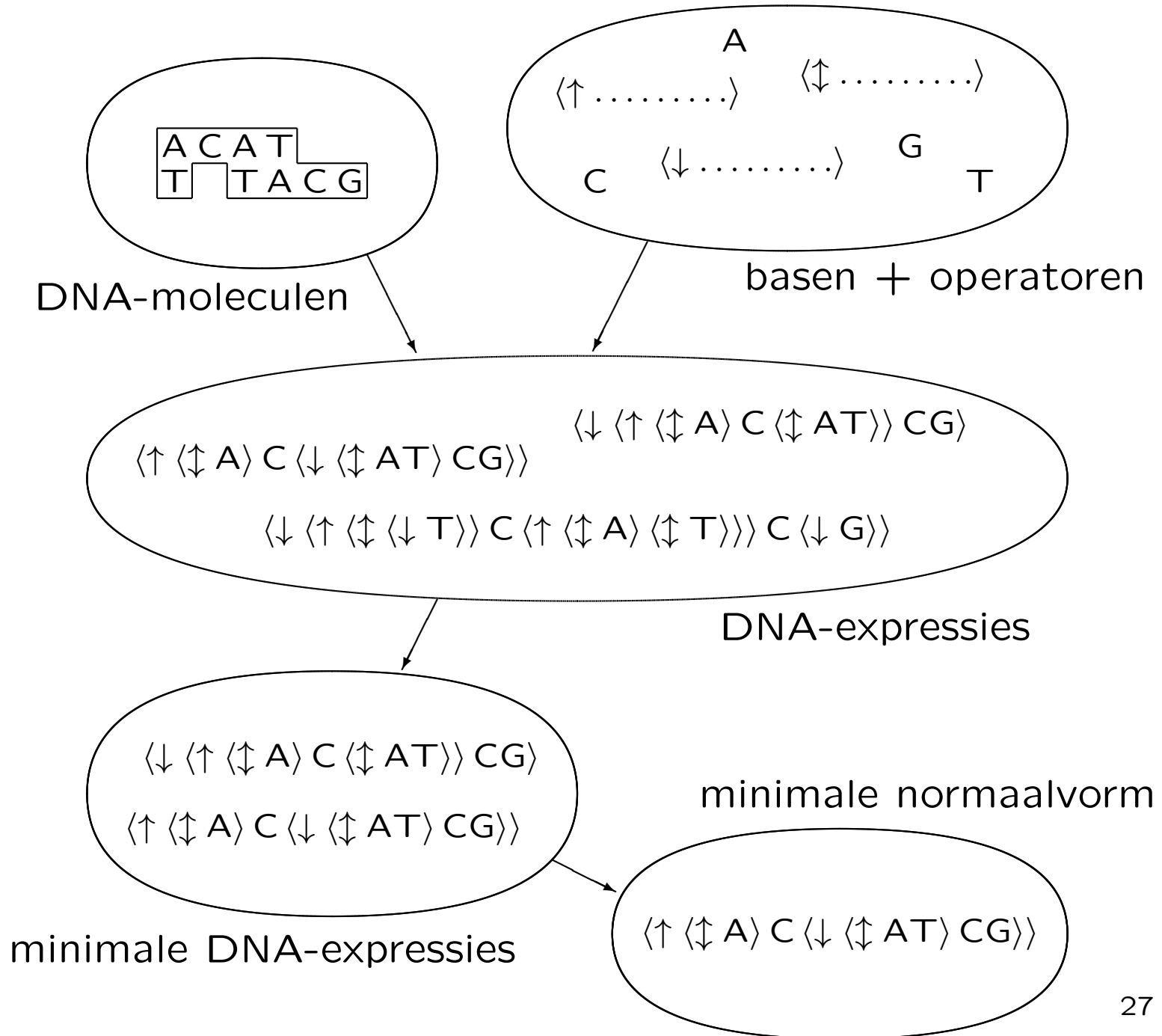

Proosten

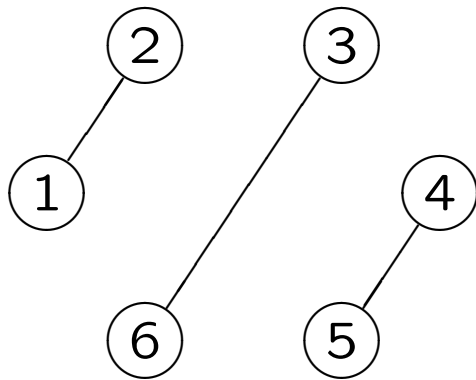

OK

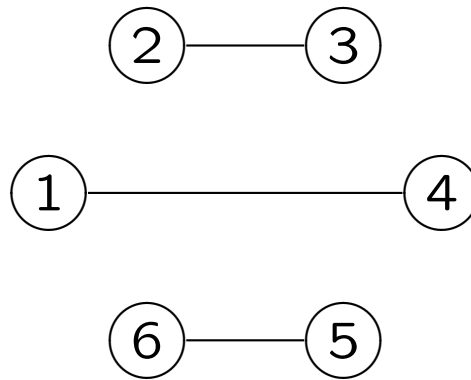

OK

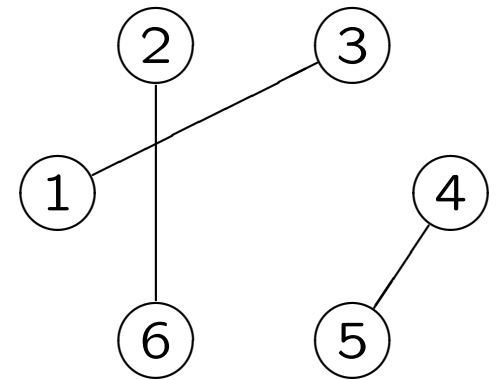

niet OK

Proosten

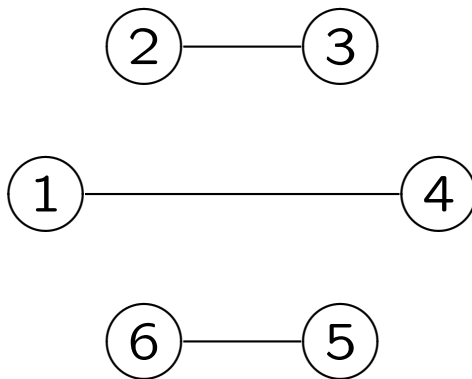
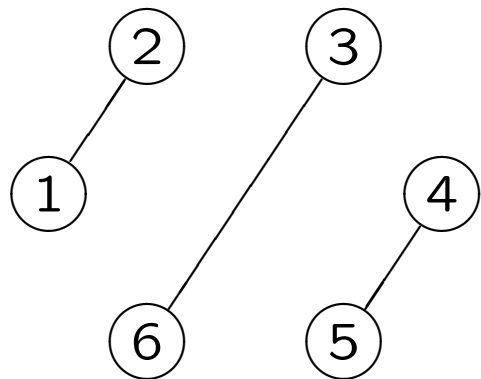

$$C_3 = 5$$

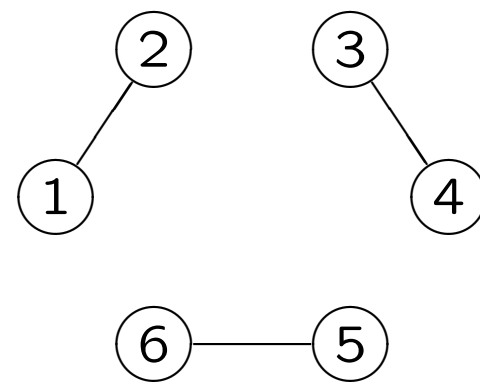
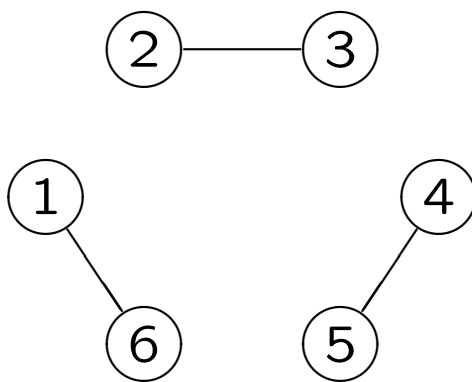
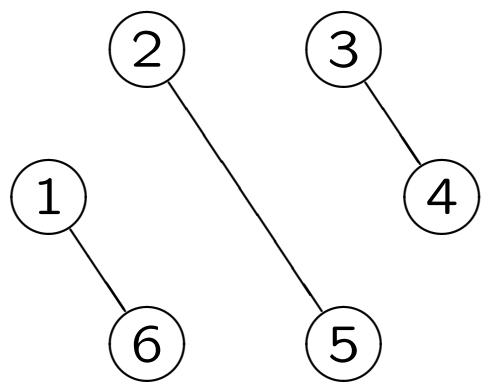

Catalan-getallen

p	C_p
0	1
1	1
2	2
3	5
4	14

p	C_p
5	42
6	132
7	429
8	1.430
9	4.862

p	C_p
10	16.796
11	58.786
12	208.012
13	742.900
14	2.674.440

p	C_p
15	9.694.845
16	35.357.670
17	129.644.790
18	477.638.700
19	1.767.263.190

Minimale DNA expressies

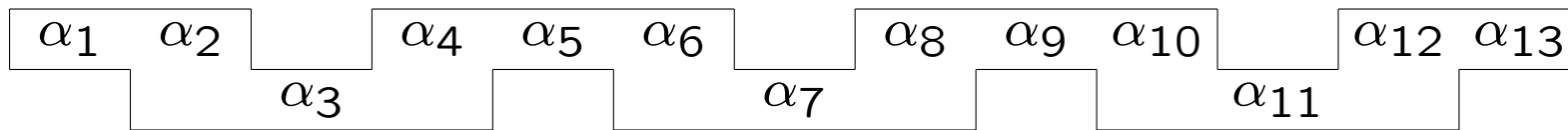

$$\langle \uparrow \alpha_1 \langle \downarrow \langle \updownarrow \alpha_2 \rangle \alpha_3 \langle \updownarrow \alpha_4 \rangle \rangle \alpha_5 \langle \downarrow \langle \updownarrow \alpha_6 \rangle \alpha_7 \langle \up \langle \updownarrow \alpha_8 \rangle \alpha_9 \langle \updownarrow \alpha_{10} \rangle \rangle \alpha_{11} \langle \updownarrow \alpha_{12} \rangle \rangle \alpha_{13} \rangle$$

$$\langle \uparrow \alpha_1 \langle \downarrow \langle \updownarrow \alpha_2 \rangle \alpha_3 \langle \up \langle \updownarrow \alpha_4 \rangle \alpha_5 \langle \updownarrow \alpha_6 \rangle \rangle \alpha_7 \langle \updownarrow \alpha_8 \rangle \rangle \alpha_9 \langle \downarrow \langle \updownarrow \alpha_{10} \rangle \alpha_{11} \langle \updownarrow \alpha_{12} \rangle \rangle \alpha_{13} \rangle$$

$$\langle \uparrow \alpha_1 \langle \downarrow \langle \updownarrow \alpha_2 \rangle \alpha_3 \langle \up \langle \updownarrow \alpha_4 \rangle \alpha_5 \langle \downarrow \langle \updownarrow \alpha_6 \rangle \alpha_7 \langle \updownarrow \alpha_8 \rangle \rangle \alpha_9 \langle \updownarrow \alpha_{10} \rangle \rangle \alpha_{11} \langle \updownarrow \alpha_{12} \rangle \rangle \alpha_{13} \rangle$$

$$\langle \uparrow \alpha_1 \langle \downarrow \langle \updownarrow \alpha_2 \rangle \alpha_3 \langle \up \langle \updownarrow \alpha_4 \rangle \alpha_5 \langle \updownarrow \alpha_6 \rangle \rangle \alpha_7 \langle \up \langle \updownarrow \alpha_8 \rangle \alpha_9 \langle \updownarrow \alpha_{10} \rangle \rangle \alpha_{11} \langle \updownarrow \alpha_{12} \rangle \rangle \alpha_{13} \rangle$$

$$\langle \uparrow \alpha_1 \langle \downarrow \langle \updownarrow \alpha_2 \rangle \alpha_3 \langle \updownarrow \alpha_4 \rangle \rangle \alpha_5 \langle \downarrow \langle \updownarrow \alpha_6 \rangle \alpha_7 \langle \updownarrow \alpha_8 \rangle \rangle \alpha_9 \langle \downarrow \langle \updownarrow \alpha_{10} \rangle \alpha_{11} \langle \updownarrow \alpha_{12} \rangle \rangle \alpha_{13} \rangle$$

Minimale DNA expressies

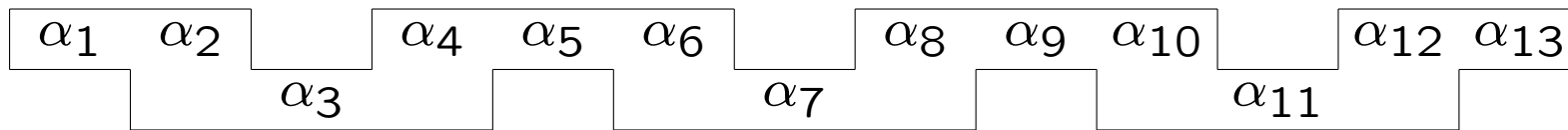

$\langle \uparrow \alpha_1 \langle \downarrow \langle \updownarrow \alpha_2 \rangle \alpha_3 \langle \updownarrow \alpha_4 \rangle \rangle \alpha_5 \langle \downarrow \langle \updownarrow \alpha_6 \rangle \alpha_7 \langle \up \langle \updownarrow \alpha_8 \rangle \alpha_9 \langle \updownarrow \alpha_{10} \rangle \rangle \alpha_{11} \langle \updownarrow \alpha_{12} \rangle \rangle \alpha_{13} \rangle$

$\langle \uparrow \alpha_1 \langle \downarrow \langle \updownarrow \alpha_2 \rangle \alpha_3 \langle \up \langle \updownarrow \alpha_4 \rangle \alpha_5 \langle \updownarrow \alpha_6 \rangle \rangle \alpha_7 \langle \updownarrow \alpha_8 \rangle \rangle \alpha_9 \langle \downarrow \langle \updownarrow \alpha_{10} \rangle \alpha_{11} \langle \updownarrow \alpha_{12} \rangle \rangle \alpha_{13} \rangle$

$\langle \uparrow \alpha_1 \langle \downarrow \langle \updownarrow \alpha_2 \rangle \alpha_3 \langle \up \langle \updownarrow \alpha_4 \rangle \alpha_5 \langle \downarrow \langle \updownarrow \alpha_6 \rangle \alpha_7 \langle \updownarrow \alpha_8 \rangle \rangle \alpha_9 \langle \updownarrow \alpha_{10} \rangle \rangle \alpha_{11} \langle \updownarrow \alpha_{12} \rangle \rangle \alpha_{13} \rangle$

$\langle \uparrow \alpha_1 \langle \downarrow \langle \updownarrow \alpha_2 \rangle \alpha_3 \langle \up \langle \updownarrow \alpha_4 \rangle \alpha_5 \langle \updownarrow \alpha_6 \rangle \rangle \alpha_7 \langle \up \langle \updownarrow \alpha_8 \rangle \alpha_9 \langle \updownarrow \alpha_{10} \rangle \rangle \alpha_{11} \langle \updownarrow \alpha_{12} \rangle \rangle \alpha_{13} \rangle$

$\langle \uparrow \alpha_1 \langle \downarrow \langle \updownarrow \alpha_2 \rangle \alpha_3 \langle \updownarrow \alpha_4 \rangle \rangle \alpha_5 \langle \downarrow \langle \updownarrow \alpha_6 \rangle \alpha_7 \langle \updownarrow \alpha_8 \rangle \rangle \alpha_9 \langle \downarrow \langle \updownarrow \alpha_{10} \rangle \alpha_{11} \langle \updownarrow \alpha_{12} \rangle \rangle \alpha_{13} \rangle$

Minimale DNA expressies

$\langle \uparrow \alpha_1 \langle \downarrow \langle \updownarrow \alpha_2 \rangle \alpha_3 \langle \updownarrow \alpha_4 \rangle \rangle \alpha_5 \langle \downarrow \langle \updownarrow \alpha_6 \rangle \alpha_7 \langle \up \langle \updownarrow \alpha_8 \rangle \alpha_9 \langle \updownarrow \alpha_{10} \rangle \rangle \alpha_{11} \langle \updownarrow \alpha_{12} \rangle \rangle \alpha_{13} \rangle$

1-2, 3-6, 4-5

$\langle \uparrow \alpha_1 \langle \downarrow \langle \updownarrow \alpha_2 \rangle \alpha_3 \langle \up \langle \updownarrow \alpha_4 \rangle \alpha_5 \langle \updownarrow \alpha_6 \rangle \rangle \alpha_7 \langle \updownarrow \alpha_8 \rangle \rangle \alpha_9 \langle \downarrow \langle \updownarrow \alpha_{10} \rangle \alpha_{11} \langle \updownarrow \alpha_{12} \rangle \rangle \alpha_{13} \rangle$

1-4, 2-3, 5-6

$\langle \uparrow \alpha_1 \langle \downarrow \langle \updownarrow \alpha_2 \rangle \alpha_3 \langle \up \langle \updownarrow \alpha_4 \rangle \alpha_5 \langle \downarrow \langle \updownarrow \alpha_6 \rangle \alpha_7 \langle \updownarrow \alpha_8 \rangle \rangle \alpha_9 \langle \updownarrow \alpha_{10} \rangle \rangle \alpha_{11} \langle \updownarrow \alpha_{12} \rangle \rangle \alpha_{13} \rangle$

1-6, 2-5, 3-4

$\langle \uparrow \alpha_1 \langle \downarrow \langle \updownarrow \alpha_2 \rangle \alpha_3 \langle \up \langle \updownarrow \alpha_4 \rangle \alpha_5 \langle \updownarrow \alpha_6 \rangle \rangle \alpha_7 \langle \up \langle \updownarrow \alpha_8 \rangle \alpha_9 \langle \updownarrow \alpha_{10} \rangle \rangle \alpha_{11} \langle \updownarrow \alpha_{12} \rangle \rangle \alpha_{13} \rangle$

1-6, 2-3, 4-5

$\langle \uparrow \alpha_1 \langle \downarrow \langle \updownarrow \alpha_2 \rangle \alpha_3 \langle \updownarrow \alpha_4 \rangle \rangle \alpha_5 \langle \downarrow \langle \updownarrow \alpha_6 \rangle \alpha_7 \langle \updownarrow \alpha_8 \rangle \rangle \alpha_9 \langle \downarrow \langle \updownarrow \alpha_{10} \rangle \alpha_{11} \langle \updownarrow \alpha_{12} \rangle \rangle \alpha_{13} \rangle$

1-2, 3-4, 5-6

Proosten

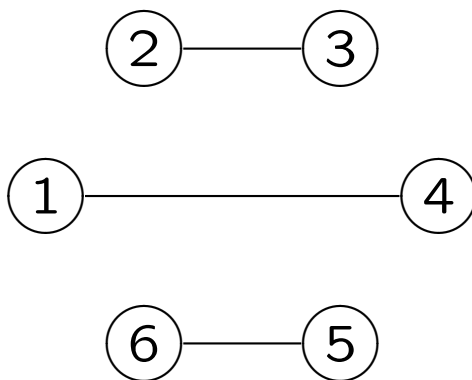
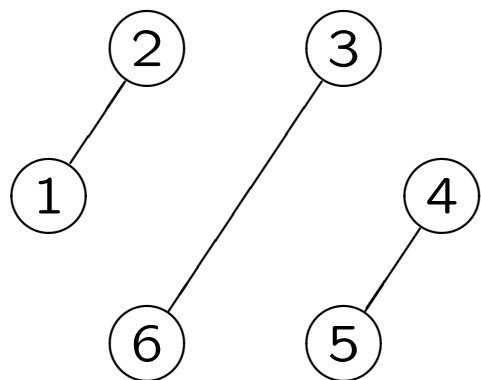

1-2, 3-6, 4-5

1-4, 2-3, 5-6

1-6, 2-5, 3-4

1-6, 2-3, 4-5

1-2, 3-4, 5-6

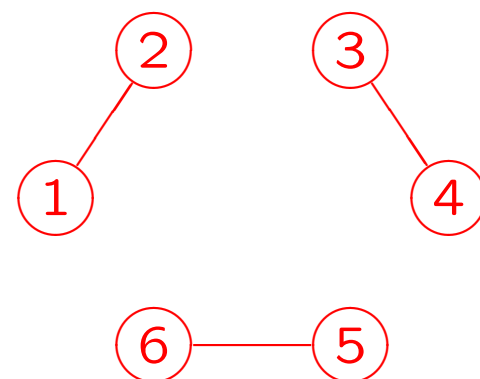
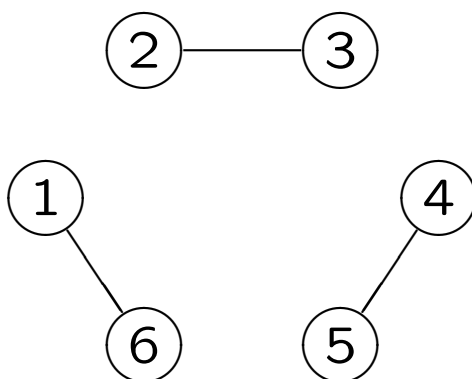
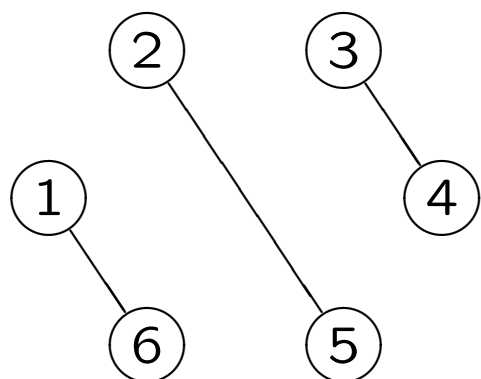

Grootte proefschrift

	totaal		zonder bijlagen	
	blz	'woorden'	blz	'woorden'
totaal	409	203795	360	178167
zonder bewijzen				
zonder voorbeelden				
zonder vergelijkingen				
zonder figuren/tabellen				

Grootte proefschrift

	totaal		zonder bijlagen	
	blz	'woorden'	blz	'woorden'
totaal	409	203795	360	178167
zonder bewijzen	292	138366	242	112695
zonder voorbeelden				
zonder vergelijkingen				
zonder figuren/tabellen				

Grootte proefschrift

	totaal		zonder bijlagen	
	blz	'woorden'	blz	'woorden'
totaal	409	203795	360	178167
zonder bewijzen	292	138366	242	112695
zonder voorbeelden	247	120065	197	94311
zonder vergelijkingen				
zonder figuren/tabellen				

Grootte proefschrift

	totaal		zonder bijlagen	
	blz	'woorden'	blz	'woorden'
totaal	409	203795	360	178167
zonder bewijzen	292	138366	242	112695
zonder voorbeelden	247	120065	197	94311
zonder vergelijkingen	235	116930	185	91228
zonder figuren/tabellen				

Grootte proefschrift

	totaal		zonder bijlagen	
	blz	'woorden'	blz	'woorden'
totaal	409	203795	360	178167
zonder bewijzen	292	138366	242	112695
zonder voorbeelden	247	120065	197	94311
zonder vergelijkingen	235	116930	185	91228
zonder figuren/tabellen	207	103970	159	78688

Grootte proefschrift

	totaal		zonder bijlagen	
	blz	'woorden'	blz	'woorden'
totaal	409	203795	360	178167
zonder bewijzen	292	138366	242	112695
zonder voorbeelden	247	120065	197	94311
zonder vergelijkingen	235	116930	185	91228
zonder figuren/tabellen	207	103970	159	78688
totaal met oude nv	475	235608		

Groote proefschrift

	totaal		zonder bijlagen	
	blz	'woorden'	blz	'woorden'
totaal	409	203795	360	178167
zonder bewijzen	292	138366	242	112695
zonder voorbeelden	247	120065	197	94311
zonder vergelijkingen	235	116930	185	91228
zonder figuren/tabellen	207	103970	159	78688
totaal met oude nv	475	235608		

Oude normaalvorm – $\frac{16}{13}$ –
 minimale DNA expressies – 268 vd 368 (> 70%)